

AGBQ SERIES GRILL SPECIFICATIONS

AGBQ-56
AGBQ-56C
AGBQ-56SZ
AGBQ-56SZC

AGBQ-56BFG
AGBQ-56BFGC

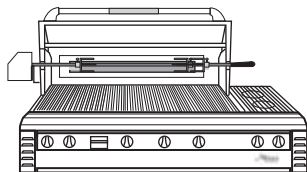

56 INCH DELUXE GRILLS

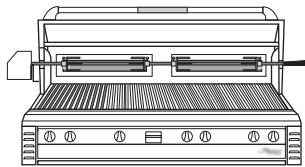

56 INCH BFG GRILLS

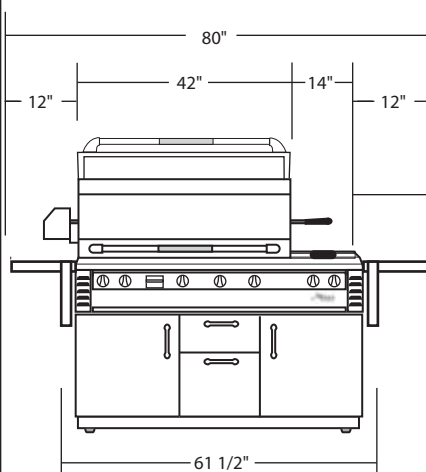

56 INCH DELUXE GRILLS

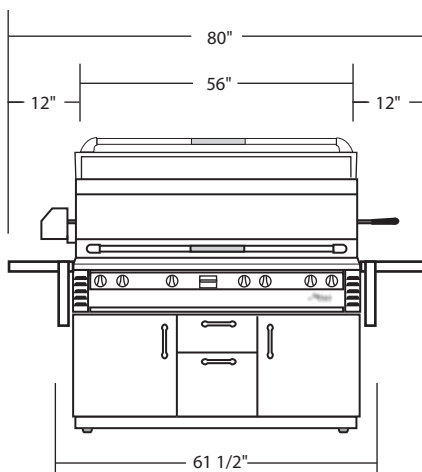

56 INCH BFG GRILLS

FRONT VIEW

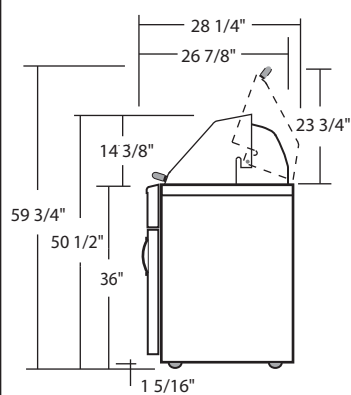

END VIEW

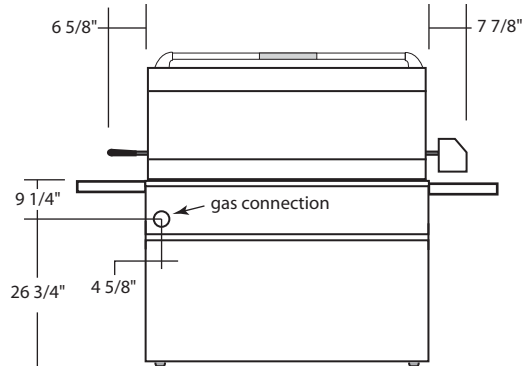

REAR VIEW

ISLAND PREPARATION

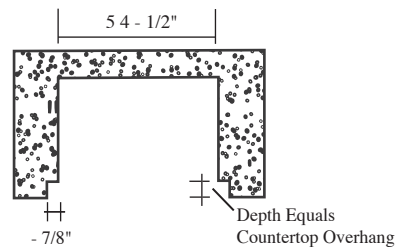
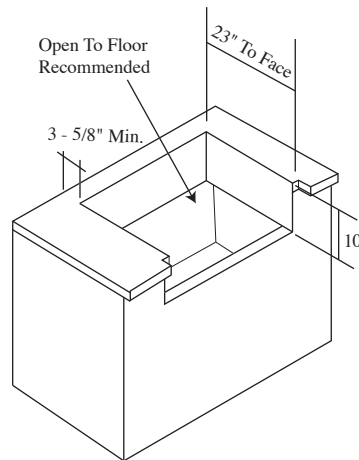

COUNTERTOP DETAIL

GAS REQUIREMENTS

Natural

- 1 / 2" NPT
- Gas Supply Pressure: 0.0" W.C

Propane (LP)

- 1 / 2" NPT
- Supply Pressure: 11" W.C
- LP Hose With Regulator Included

ELECTRICAL REQUIREMENTS

- 120 V 60Hz For Rotisserie Motor & Light Accessory

Create The Ultimate Outdoor Kitchen

ACCESSORIES & OTHER PRODUCTS

- Heavy Duty Vinyl Cover (recommended)
- Drop-in Steamer Fryer
- Drop-on Stainless Steel Griddle
- Cart Mount Double Side Burner
- Drop-on Griddle For Side Burner
- Stainless Steel Access Doors For Islands
- Stainless Steel Storage Drawers
- Built-in Sterno-fired Food Warmers
- Prep & Waste Centers For Island Installations
- Plating & Garnish centers
- Warming Drawers
- Built-in & Cart Model Cocktail Stations
- Built-in Prep & Hand Sink
- Refrigerator / Keggerator
- Under-Grill Refrigerator w/ Marinating Drawers
- Built-in Countertop Refrigerator
- Completely Sealed Dry Storage Pantry Centers

MODEL NUMBER	AGBQ-5 6	AGBQ-5 6 BFG
GRILLING AREA	7 7 0 SQ. INCHES	9 9 8 SQ. INCHES
MAIN GRILL BURNERS	3 @ 2 7 , 5 0 0 BTU EA.	4 @ 2 7 , 5 0 0 BTU EA.
SIDE BURNERS	2 @ 1 7 , 0 0 BTU EA.	—
ROTISSERIE BURNER	1 8 , 0 0 0 BTU	2 @ 1 5 , 0 0 0 BTU
SMOKER BURNER	7 , 0 0 0 BTU	7 , 0 0 0 BTU
APPLIANCE TOTAL BTU	1 7 5 , 5 0 0 BTU	1 4 7 , 0 0 0 BTU
SHIPPING WEIGHT (built-in)	3 1 5 lbs	3 2 0 lbs
SHIPPING WEIGHT (on cart)	4 5 5 lbs	4 6 0 lbs
SHIPPING WEIGHT (w/ refrig.)	6 2 1 lbs	6 2 1 lbs

Alfresco Open Air Culinary Systems
7039 East Slauson Avenue Commerce, CA 90040
PH: (323)-722-7900 FAX: (323) 726-4700 Toll Free (888) 383-8800
www.alfrescogrills.com